

RACK-PAL SPECIAL 34"  
WRAP BOTH ENDS

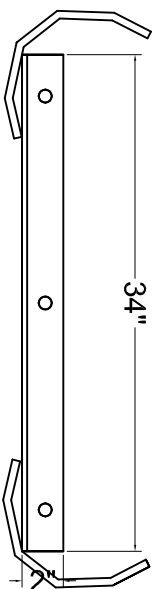

Quantity: 1

RACK-PAL SPECIAL 44"  
WRAP BOTH ENDS

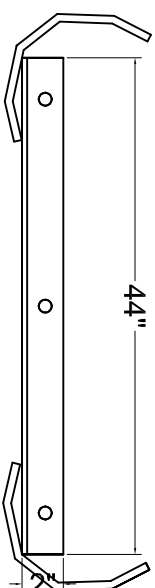

Quantity: 1

RACK-PAL 48"  
WRAP BOTH ENDS

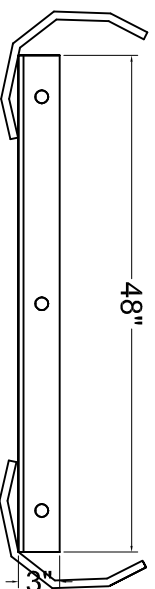

Quantity: 4

RACK-PAL LEFT 44"

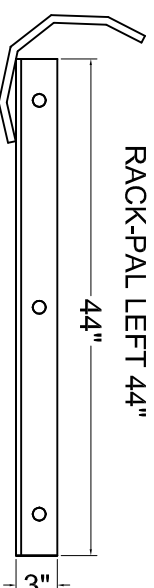

Quantity: 3

RACK-PAL SPECIAL RIGHT 55"

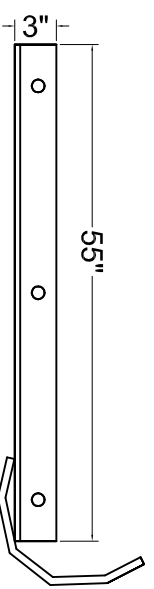

Quantity: 2

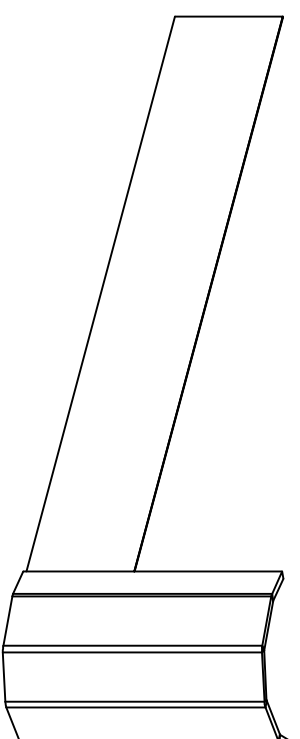
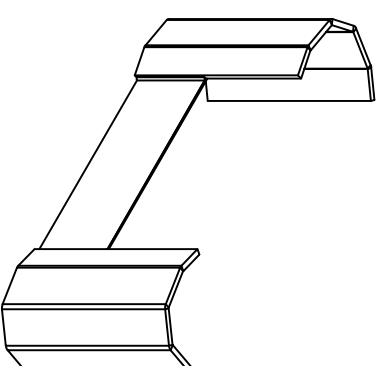

**RACKPAL SPECIFICATIONS:**

- RACKPAL CRESCENT MADE OF FORMED METAL 3/8"
- RACKPAL CRESCENT HEIGHT: 12"
- RACKPAL ANGLE 3"x5"x1/4"

**FIELD MEASUREMENTS**  
ALL FIELD MEASUREMENTS MUST BE VERIFIED AND GIVEN TO COGAN, IN OPENING SIZE WITH NO REDUCTIONS. COGAN WILL REDUCE ALL OPENINGS ACCORDING TO THEIR NEED FOR DOOR AND PANEL CLEARANCE REQUIREMENTS.

**LEGEND:**

- ARL: ACTUAL RAIL LENGTH
- C/C: CENTER TO CENTER
- O.D.: OUTSIDE DIMENSION
- THE COMPONENTS ARE COLORED WITH ONE COAT OF COGAN POWDER YELLOW PAINT.

**CHECK & RETURN PROMPTLY \* JOB SHIP DATE SET AFTER RECEIPT OF FINAL APPROVAL \***

**DIMENSIONS & DESIGN SHOWN**

- APPROVED (NO CHANGES)
- APPROVED WITH CHANGES
- REVISE & RESUBMIT
- NOT APPROVED

SIGN: \_\_\_\_\_

PRINT NAME: \_\_\_\_\_

BY APPROVING THESE DRAWINGS, THE CLIENT AND/OR OWNER ARE ACCEPTING THAT THESE DESIGNS MAY BE OR ARE AN ALTERNATIVE TO THE SPECS AND/OR DESIGNS PREVIOUSLY PROVIDED TO COGAN.

DO NOT MAKE ANY MODIFICATIONS TO CORRECT ANY PROBLEM, BE IT PRODUCT OR SITE CONDITION, WITHOUT FIRST CONTACTING OUR CUSTOMER SUPPORT DEPARTMENT AT COGAN WIRE (1-800-567-2642). DOING SO MAY AFFECT YOUR PRODUCT WARRANTY AND COGAN WILL NOT BE RESPONSIBLE FOR ANY UNAUTHORIZED WORK. CUSTOMER SUPPORT IS AVAILABLE DURING REGULAR BUSINESS HOURS 8AM-5PM, MONDAY-FRIDAY.

**IMPORTANT NOTE**

THE CLIENT AND/OR OWNER SHALL BE RESPONSIBLE FOR ALL QUANTITIES AND DIMENSIONS INCLUDING THE VERIFICATION OF, AND COORDINATION WITH FIELD CONDITIONS. THE CLIENT AND/OR OWNER SHALL VERIFY ALL CRITICAL DIMENSIONS AND CONDITIONS OF EXISTING CONSTRUCTION THAT RELATE TO THIS PROJECT PRIOR TO MANUFACTURING. COGAN MUST BE NOTIFIED IN WRITING OF ANY ELEMENTS FOUND TO BE INCONSISTENT OR NOT COMPATIBLE WITH THE DETAILS INDICATED BY THESE APPROVAL DRAWINGS.

THE CLIENT AND/OR OWNER MUST SUBMIT SIGNED (APPROVED) DRAWINGS PRIOR TO THE START OF THE PRODUCTION.



**Cogan** Guardrails

PROJECT NAME:

\*\*\*

CLIENT NAME:

\*\*\*

SCALE:

NTS

DATE:	DRAWN BY:	VERIFIED BY:	REVISION:	PAGE:
***	***	***	X	1/1